

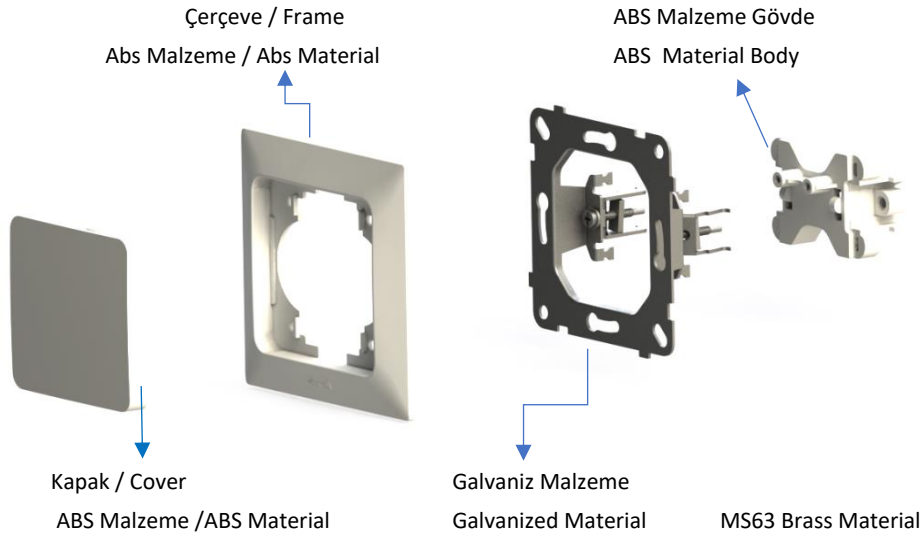

Ürün Kodu / Product Code: 93-1XX-63

Genel Teknik Bilgiler / General Technical Informations



Genel Teknik Ölçüler / General Technical Dimensions

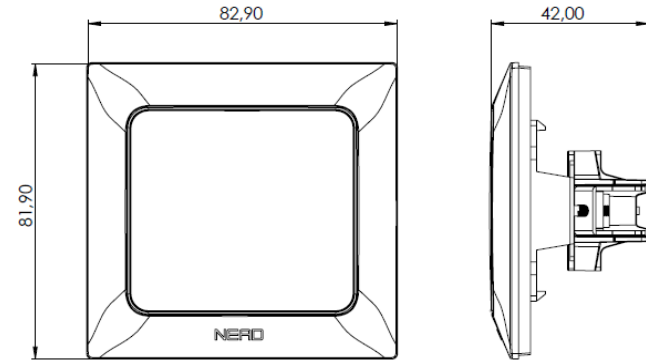

Ürün Montajı / Product Assembly

- 1- Modül montaj yapılacak kasa içerisine yerleştirilip ve tırnak vidaları ile sıkıştırılarak sabitlenir.
The module is inserted into the enclosure and fixed by tightening with claw screws.
- 2-Göbek çerçeveye takılır.
The central plate is assembled to frame.
- 3-Çerçeve şasenin üzerine konumlandırılır ve göbek vidası ile sıkılarak montaj yapılır.
The frame is placed on the chassis and the assembly is completed by screwing the hub screw.

